

**COLOR
TELEVISION**

**ELEGANCE 37
LXW 94-8616 DOLBY**

**ELEGANCE 40
LXW 102-8616 DOLBY**

**DEUTSCH
ENGLISH
FRANÇAIS
ITALIANO
NEDERLANDS
POLSKI**

GERMIG

CONTENTS

3-4

Set-up and safety

5-6

Connection/Preparation

5

Mounting the table base

5

Connecting the loudspeakers

6

Connecting the antenna and the mains cable

6

Inserting batteries in the remote control

7-10

Overview

7

Connections on the television

8

Controls on the television

9-10

The remote control

11-14

Settings

11

Setting television channels automatically

11-12

Changing stored channels

12

Picture settings

13-14

Audio settings

15-19

Television operation

15-16

Basic functions

16

Zap function

17

Zoom function

18

Changing the picture format

19

PIP mode

20-21

Teletext mode

20

TOP text or FLOF text mode

20

Normal text mode

20-21

Additional functions

22

Convenience functions

22

Convenience functions with the »Features« menu

23-28

Using external devices

23-26

DVD player, DVD recorder, video recorder or set-top box

27

Decoder or satellite receiver

27

Hi-fi system/AV receiver

28

Camcorder

29

PC Monitor Mode

29

Connecting a PC

29

Selecting the channel position for the PC

29

Settings for the PC

30-32

Special settings

30-32

Setting television channels

33-35

Information

33

Technical data,

33

Service information for dealers

33

Environmental note

34

Troubleshooting

35

Additional Information for units sold in the UK.

SET-UP AND SAFETY

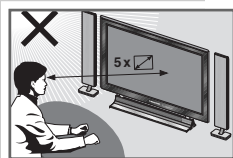

Please note the following information when setting up your television set.

This television set is designed to receive and display video and audio signals.

Any other use is expressly prohibited.

The ideal viewing distance is 5 times the screen diagonal.

External light falling on the screen impairs picture quality.

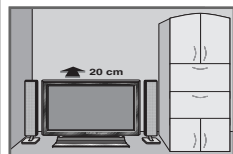

To assure sufficient ventilation make sure there is enough space around it in the wall unit.

The television set is designed for use in dry rooms. If you do use it in the open, please ensure that it is protected from moisture, such as rain or splashing water. Do not expose the television set to any moisture.

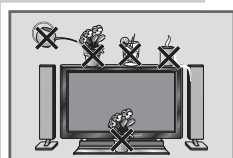

Do not place any vessels such as vases on the television, as they may spill liquid, thus presenting a safety risk.

Place the television set on a solid, level surface. Do not place any objects such as newspapers on the television set or cloth or similar items beneath it.

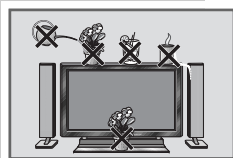

Do not place the television set close to heating units or in direct sunlight, as this will impair cooling.

Heat build-up can be dangerous and shortens the operating life of the television set. For reasons of safety, have a specialist remove any dirt deposits in the set from time to time.

Do not open the television set under any circumstances. Warranty claims are excluded for damage resulting from improper handling.

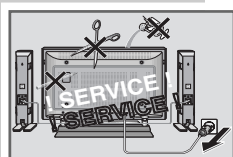

Make sure the power cord or the power supply unit (if provided) are not damaged.

The television set may only be operated with the mains cable/adaptor supplied.

Thunderstorms are a danger to all electrical devices. Even if the television set is switched off, it can be damaged by a lightning strike to the mains or the antenna cable. Always disconnect the mains and antenna plugs during a storm.

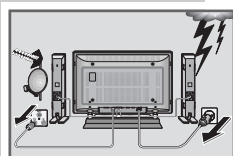

Clean the screen with a soft, damp cloth. Only use plain water.

Note:

Do not connect any other equipment while the device is switched on. Switch off the other equipment as well before connecting it.

Only plug the device into the mains socket after you have connected the external devices and the antenna.

SET-UP AND SAFETY

Please note when deciding where to put the device that furniture surfaces are covered by various types of lacquer and plastic, most of which contain chemical additives. These may cause corrosion to the feet of the device, thus resulting in stains on the surface of the furniture which can be difficult or impossible to remove.

The screen of your LCD television meets the highest quality standards and has been checked for pixel faults.

Despite the great care taken in manufacturing, technological reasons make it impossible to completely discount the possibility that some pixels may be faulty.

Provided they are within the thresholds specified by the DIN norm, pixel faults of this kind cannot be regarded as a defect as defined by the warranty.

CONNECTION/PREPARATION

Mounting the table base

Diagrams are contained in the assembly instructions enclosed with the table base.

- 1 Fasten the two brackets to the table base using the hex socket screws supplied.
- 2 Remove four fixing screws for each bracket from the back of the device.
- 3 Place the stand on a level surface.
- 4 Put the device on top of the stand.
- 5 Fasten the stand to the device by screwing four screws to the back of the device for each bracket.

Connecting the loudspeakers

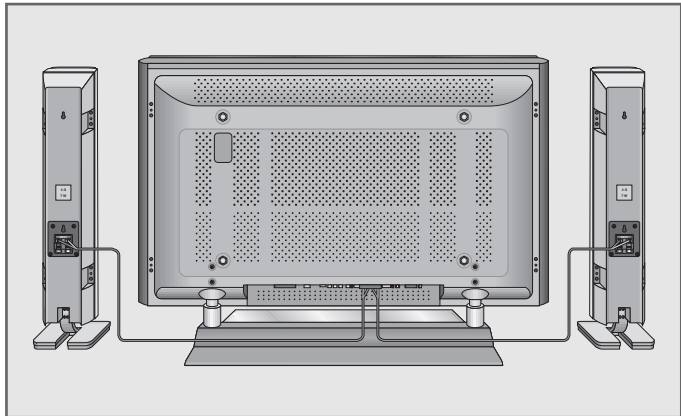

- 1 Use the speaker cable supplied to connect the »**SPEAKER OUT** - +« terminals on the device to the »**INPUT** - +« terminals on each speaker.
Connect the cables marked in red to the red terminal.

CONNECTION/PREPARATION

Connecting the antenna and the mains cable

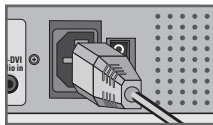
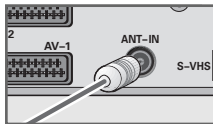
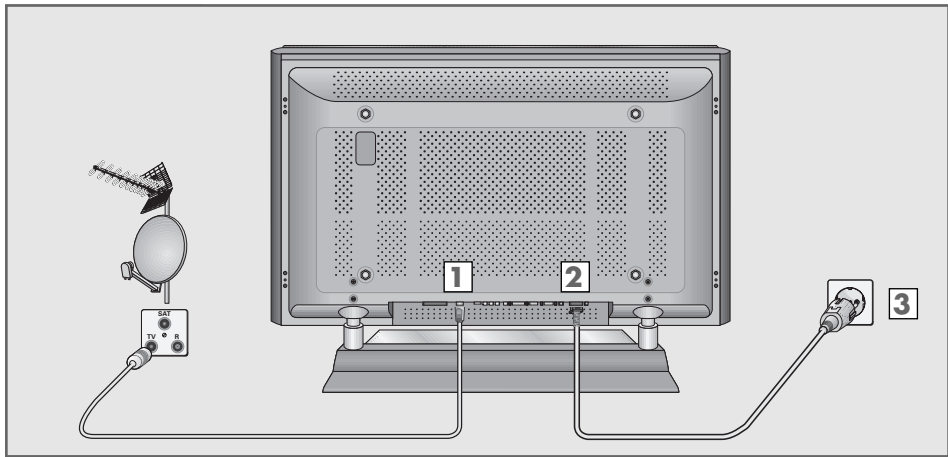

- 1 Plug the antenna cable of the rooftop antenna into the »ANT IN« antenna socket on the television.
- 2 Plug the mains cable supplied into the »AC IN« mains socket of the television.
- 3 Plug the mains cable into the wall socket.

Note:

Only plug the device into the mains socket after you have connected the external devices and the antenna.

Inserting batteries in the remote control

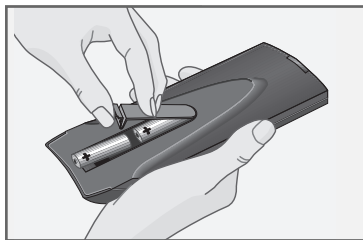

- 1 Open the battery compartment by removing the lid.
- 2 Insert the batteries (Mignon type, for example UM-3 or AA, 2x1,5V). Observe the polarity (marked on the base of the battery compartment).
- 3 Close the battery compartment.

Note:

If the television no longer reacts properly to remote control commands, the batteries may be flat. Be sure to remove used batteries.

The manufacturer accepts no liability for damage resulting from used batteries.

Environmental note

Batteries, including those which contain no heavy metal, may not be disposed of with household waste. Please dispose of used batteries in an environmentally sound manner. Find out about the legal regulations which apply in your area.

OVERVIEW

Connections on the television

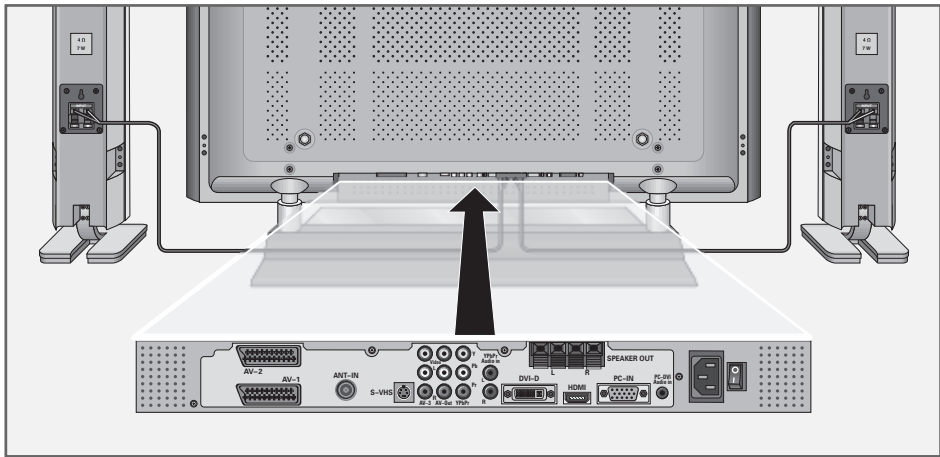

AV-2

Euro/AV socket (FBAS signal).

AV-1

Euro/AV socket (FBAS signal, RGB signal).

ANT-IN

Antenna socket.

S-VHS

Video signal input for S-Video camcorder.

AV-3 Video

Video signal input for camcorder.

AV-3 L R

Audio signal input for camcorder.

AV-Out Video L R

Audio and video output.

Y Pb/Pr

Video signal input (YUV signal).

Y Pb/Pr Audio In L R

Audio signal input (YUV signal).

SPEAKER OUT L R

Terminals for connecting external loudspeakers (2 x 20 W music power, 2 x 10 W sine wave, impedance 4 Ω);
R = right channel, **L** = left channel.

DVI-D

DVI-D socket, video signal input for PC (DVI).

HDMI

HDMI socket, audio/video signal input (HDMI).

PC-IN

VGA socket, video signal input for PC.

PC-DVI Audio In

Audio signal input for PC.



Socket for the mains cable.

IO

Power switch, switches the device to and from standby mode.

OVERVIEW

Controls on the television









Operation indicator
Red – standby
Blue – operation.

OVERVIEW

The remote control



-  Switches off the television set (stand-by).
- 1...0** Switches the television on from standby mode
Selects channels directly.
- ?** Displays the number and name of a station.
Switches to double character size in teletext mode.
-  Switches between picture formats.
Page stop in teletext mode.
- PIP** Shows an inset picture;
activates the double window function (two different TV programmes on separate halves of the screen);
switches back to normal size.
- AV** Opens the pre-selection for AV channels.
Then selection with **P+** or **P-**.
-  Sound on/off (mute).
- i** Calls up the »Main menu«.
- Z** Zap function.
- P+, P-** Switches the television on from standby;
selects stations step by step;
moves the cursor in the menus up and down.
-  Adjusts the volume;
moves the cursor left/right.
- OK** Calls up the preset channels;
activates various functions.
- TXT** Switches between teletext and TV modes
- TV-G** Key has no function.
-  Selects various picture settings;
scrolls back a page in teletext mode.
-  Displays the time;
selects the next page in teletext mode.
-  Freeze-frame;
selects the desired chapter in teletext mode.
- ?** Selects various audio settings;
selects the desired topic in teletext mode.

OVERVIEW



- SCAN** Reveals answers in teletext mode.
- PAT** Selects the Double Window function.
- S** Selects the sub-pages in teletext mode.
- P** Updates a page in teletext mode.
- DR, DVD** Switches to operation of a GRUNDIG digital receiver, GRUNDIG digital receiver with hard disk (PDR), GRUNDIG DVD player or GRUNDIG DVD recorder.
Keep the appropriate button (»DR«, »DVD«) pressed down. Then press the appropriate button.

Note:

The »DR« button has been programmed for operating a GRUNDIG digital receiver (remote control level 1). The »DVD« button has been programmed for operating a GRUNDIG DVD player. You can change this programming, see »AUX« button. The functions available depend on the model of the device you are using. Just try it out.

- AUX** Programming the remote control for the operation of external devices.
Press »AUX« and hold it down and press three numerical buttons to enter the appropriate code:
»1«, »2«, »3« for a GRUNDIG DVD player.
»4«, »5«, »6« for a GRUNDIG DVD recorder.
»1«, »4«, »7« for a GRUNDIG digital receiver (remote control level 1).
»2«, »5«, »8« for a GRUNDIG digital receiver (remote control level 2).
»3«, »6«, »9« for a GRUNDIG digital receiver with hard disk (PDR).

SETTINGS

Setting television channels automatically

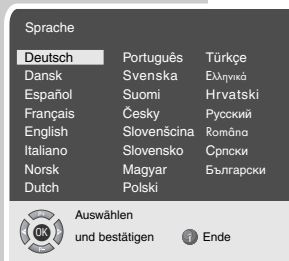

The television set is equipped with an automatic channel search system.

You start the search and can then sort the television channels into your order of preference.

99 preset positions are provided, to which you can assign television channels from the antenna or from the cable connection.

- 1 Switch on the television with »**IO**« on the television set, then press »**P+**« on the remote control.
– The »Sprache« (Menu language) menu appears when the television is first switched on.

Hint:

If the »Sprache« (Menu language) menu does not appear on the screen, then set it in accordance with the chapter on resetting all television channels on page 32.

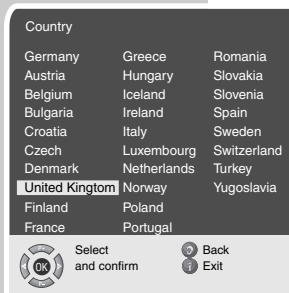

- 2 Select language with »**P+**«, »**P-**«, »**◀**« or »**▶**« and press »**OK**« to confirm.
– The »Country« menu appears.

- 3 Press »**P+**«, »**P-**«, »**◀**« or »**▶**« to select the country and »**OK**« to confirm.
– The search begins. It may last a few minutes, depending on the number of television stations found.
– After the search the television switches to channel position 1 and the »Program table« menu appears.

Changing stored channels

You can delete channels that have been stored more than once during the automatic search. You can also store channels in a different preset position, change or enter the name of a channel as well as skip channels.

Deleting channels

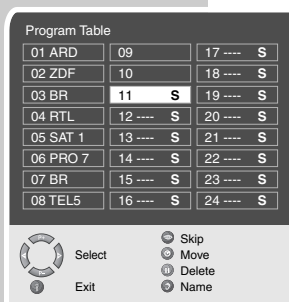

- 1 In the »Program table« menu, select the station to be deleted with »**P+**«, »**P-**«, »**◀**« or »**▶**«.
- 2 Highlight the channel with »**□□**« (yellow).
- 3 Press »**□□**« (yellow) to delete the channel.

Note:

To delete other stations, repeat steps 1 and 3.

SETTINGS

Sorting television channels

- 1 In the »Program table« menu, select the channel to be moved with with »P+«, »P-«, »◀« or »▶«.
- 2 Highlight the channel with »⌂« (green).
- 3 Select a new channel position by pressing »P+«, »P-«, »◀« or »▶« and then press »⌂« to confirm.
– All of the channels that follow move up one position.

Note:

To sort the other television channels repeat steps 1 to 3.

Entering the channel names (maximum of 5 characters)

- 1 In the »Program table« menu, select the desired channel with »P+«, »P-«, »◀« or »▶«.
- 2 Highlight the channel with »⌂« (blue).
- 3 Select letters or numbers with »P+« or »P-«, move to the next position with »◀« or »▶« and repeat.
- 4 Store the channel name with »OK«.

Note:

To enter additional channel names, repeat steps 1 to 4.

Skipping television channels

You can mark television channels which should be skipped during selection with »P+« or »P-«. A selection with the number keys is also possible.

- 1 In the »Program table« menu, select the desired channel with »P+«, »P-«, »◀« or »▶«.
- 2 Highlight the channel with »⊗« (red).
– An »S« appears behind the name of the television station.
– You can deselect the selected channel by pressing the red button again.

Concluding the settings

- 1 Press »i« to finish the settings.

Program Table

01 ARD	09	17 ---- S
02 ZDF	10	18 ---- S
03 BR	11 S	19 ---- S
04 RTL	12 ---- S	20 ---- S
05 SAT 1	13 ---- S	21 ---- S
06 PRO 7	14 ---- S	22 ---- S
07 BR	15 ---- S	23 ---- S
08 TEL5	16 ---- S	24 ---- S

Select

Exit

- ⊗ Skip
- ⌂ Move
- Ⓜ Delete
- Ⓝ Name

Program Table

01 ARD	09	17 ---- S
02 ZDF	10	18 ---- S
03 BR	11 S	19 ---- S
04 RTL	12 ---- S	20 ---- S
05 SAT 1	13 ---- S	21 ---- S
06 PRO 7	14 ---- S	22 ---- S
07 BR	15 ---- S	23 ---- S
08 TEL5	16 ---- S	24 ---- S

Select

Exit

- ⊗ Skip
- ⌂ Move
- Ⓜ Delete
- Ⓝ Name

Program Table

01 ARD S	09	17 ---- S
02 ZDF	10	18 ---- S
03 BR	11 S	19 ---- S
04 RTL	12 ---- S	20 ---- S
05 SAT 1	13 ---- S	21 ---- S
06 PRO 7	14 ---- S	22 ---- S
07 BR	15 ---- S	23 ---- S
08 TEL5	16 ---- S	24 ---- S

Select

Exit

- ⊗ Skip
- ⌂ Move
- Ⓜ Delete
- Ⓝ Name

SETTINGS

Picture settings

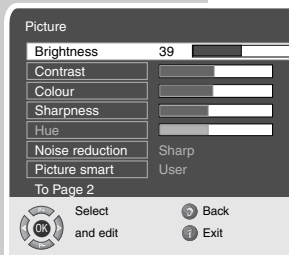

- 1 Press »i« to open the »MAIN MENU«.
– The »MAIN MENU« appears.
 - 2 Select »Picture« with »P+« or »P-« and confirm with »OK«.
– The »Picture« menu appears.
 - 3 Select »Default settings« with »P+« or »P-« and the setting »User« with »◀« or »▶«.
 - 4 Select »Brightness«, »Contrast«, »Colour«, »Sharpness« or »Noise reduction« with »P+« or »P-« and press »OK« to confirm.
- Note:**
The setting »Hue« only applies to NTSC programmes (e.g. for playback of American television programmes on the video recorder).
- 5 Press »◀« or »▶« to select the level, and then press »OK« to confirm.
 - 6 Press »i« to finish the settings.

Audio settings

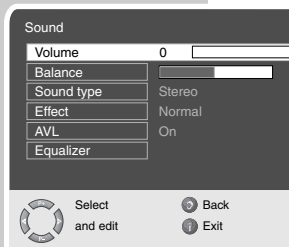

- 1 Press »i« to open the »MAIN MENU«.
– The »MAIN MENU« appears.
- 2 Select »Sound« with »P+« or »P-« and confirm with »OK«.
– The »Sound« menu appears.

Volume

- 1 Select »Volume« with »P+« or »P-« and adjust the setting with »◀« or »▶«.

Balance

- 1 Select »Balance« with »P+« or »P-« and adjust the setting with »◀« or »▶«.

Stereo / two channel, mono

If the device receives two channel programmes, e.g. a film with the original sound on sound channel B (display: »Dual B «) and the dubbed version on sound channel A (display: »Dual A«), you can select the sound channel you desire.

If the device receives stereo or Nicam programmes, it switches automatically to stereo sound (display: »Stereo«).

You can switch the sound to »Mono« if the stereo reception quality is poor.

- 1 Select »Sound type« with »P+« or »P-« and adjust the setting with »◀« or »▶«.

SETTINGS

Dolby Virtual*

Dolby Virtual is an innovative electronic solution, which is integrated in the television set and only requires the built-in speakers to produce Dolby Surround effects.

- 1 Select »Sound mode« with »P+« or »P-«.
- 2 Select »Dolby Virtual« with »◀« or »▶«.

Stereo width

Widens the audio output for stereo programmes and improves the sound with mono reception.

- 1 Select »Sound type« with »P+« or »P-«.
- 2 Press »◀« or »▶« to select the setting.

Automatic volume

The television channels broadcast at different volumes. The automatic volume limiting (AVL) function means the volume is kept the same when you switch between channels.

- 1 Select »AVL« with »P+« or »P-« and then select »On« with »◀« or »▶«.

Equaliser

The equaliser offers you four preset sound settings (Music, Sport, Cinema and Dialogue) and one which you can create yourself (User).

- 1 Select »Equalizer« with »P+« or »P-« and confirm with »OK«.
– The »Equalizer« menu appears.
- 2 Select the audio setting »User« with »P+« or »P-« and confirm with »OK«.
– The frequency band »120 Hz« is activated.
- 3 Set the desired value with »P+« or »P-« and select the next frequency band with »◀« or »▶«.
- 4 Press »?« (blue) to save the setting.

Concluding the settings

- 1 Press »i« to finish the settings.

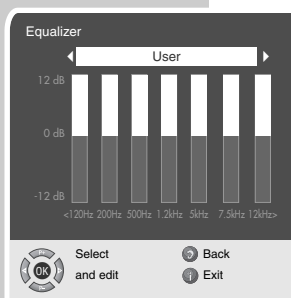

* Under license from Dolby Laboratories Licensing Corporation. DOLBY and the Double-D symbol **DD** are registered trademarks of the Dolby Laboratories Licensing Corporation.

TELEVISION OPERATION

Basic functions



Switching on and off

- 1 Press »IO« on the television set to switch it to standby.
- 2 Press »1...0« or »P+« or »P-« to switch on the device from standby mode.
- 3 Press the »⏻« button to switch the television to standby mode.
- 4 Press »IO« on the television set to switch it off completely.
– This saves electricity.

Selecting channels

- 1 Use »1...0« to select channels directly.
- 2 Press »P+« or »P-« to move up and down channels.
- 3 Open the channel list by pressing »OK«, select the station with »P+« or »P-« and press »OK« to switch off the channel list.

Selecting AV channels

- 1 Call up the »Source table« menu with »AV«.
- 2 Select the desired AV channel position with »P+« or »P-« and press »OK« to confirm.
- 3 Switch back to the television channel with »1...0«.

Adjusting the volume

- 1 Adjust the volume with »◀« or »▶«.

Muting

- 1 Use »🔇« to switch the sound off (mute) and to switch it on again.

Displaying time

- 1 You can display the time by pressing the »🕒« button (only for channels with teletext).

Displaying information

- 1 Press »?« to display the information.
– The display disappears automatically after a short while.

Freeze-frame

If you wish to view a particular scene for longer, you can freeze the frame of the current programme.

- 1 Press »🟡« (yellow).
- 2 To quit this function, press »🟡« again.

TELEVISION OPERATION

Picture settings

You can select four different picture settings.

- 1 Select the desired picture setting from »User«, »Natural«, »Rich« or »Soft« with »«.
– You can alter the »User« picture setting, see the "Picture settings" chapter on page 13.

Audio settings

You can select six different audio settings.

- 1 Select the desired sound setting from »User«, »Music«, »Sport«, »Cinema« or »Speech« with »«.
– You can alter the »User« sound settings, see the "Equaliser" chapter on page 14.

Zap function

This function allows you to save the television channel which you are currently watching and switch to other channels (zapping).

- 1 Select the channel you want to save in the zap memory with »1...0« or »P+« »P-«, (e.g. channel 1, BBC 1) and save by pressing »Z«.
– The display »BBC 1« appears in the screen.
- 2 Change channels with »1...0« or »P+« »P-«.
- 3 You can now use »Z« to switch between the saved channel (in the example, BBC1) and the channel you were watching before.
- 4 Press »« to quit the zap function.
– The display disappears.

TELEVISION OPERATION

Zoom function

This function enables you to enlarge the television or PC picture.

- 1 Press **»i«** to open the **»MAIN MENU«** menu.
– The **»MAIN MENU«** menu appears.
- 2 Select **»Picture«** with **»P+«** or **»P-«** and press **»OK«** to confirm.
– The **»Picture«** menu appears.
- 3 Select **»Brightness«** with **»P+«** or **»P-«** and press **»P+«** again.
– **»Zoom«** is selected.
- 4 Press **»OK«** to activate the zoom function.
- 5 Press **»P+«** or **»P-«** to change the size of the picture.
- 6 To change the picture section press **»OK«** and then **»◀«, »▶«, »P+«** or **»P-«** to select the section.
- 7 Press **»i«** to quit the zoom function.
– The display disappears.

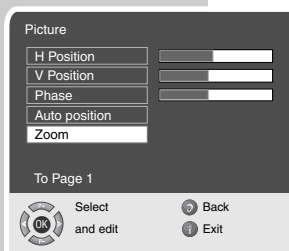

TELEVISION OPERATION

Changing the picture format

The television automatically switches to the 16:9 format if this format is detected via the Euro-AV socket.

- 1 Select the picture format with **»[]«**. The selected picture format, for example **»16:9«**, appears on the screen.
 - You can choose between the following picture formats:

»4:3« format

The picture is shown in 4:3 format.

»Auto« format

The picture format is automatically switched to **»16:9«** for 16:9 programmes.

For programmes in 4:3 format, the picture automatically fills the screen.

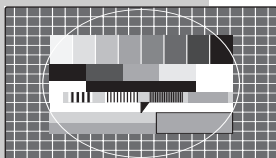

»16:9« and »14:9« formats

During programmes in 4:3 format, the picture is stretched horizontally if **»16:9«** or **»14:9«** is selected.

The picture geometry is stretched horizontally.

With actual 16:9 signal sources (from a set-top box on the Euro-AV socket) the picture fills the screen completely and with the correct geometry.



»Letterbox« format

The letterbox setting is especially suitable for programmes in 16:9 format.

The black borders which are usually at the top and bottom of the screen are eliminated, 4:3 pictures fill the screen.

The transmitted pictures are enlarged, but are slightly cropped at the top and bottom. The picture geometry remains unchanged.

The **»Auto Letterbox«** message appears for PAL Plus television programmes.

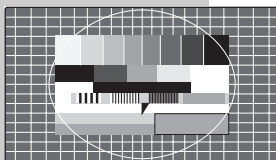

»Panorama« format

This setting is suited to films with a large width/height ratio.

During programmes in 4:3 format the picture is stretched horizontally if the **»Panorama«** function is selected. The picture geometry is stretched horizontally.

»Subtitles« format

If you cannot read the subtitles which appear on the bottom of the screen (especially during programmes with 4:3 format and if the **»Subtitles«** format is selected), then select **»Subtitles«**.

TELEVISION OPERATION

PIP mode

PIP (picture in picture) allows you to watch an inset picture from a second picture source in addition to the current channel.

Other television stations, DVD players, video recorders or satellite receivers can be used as video sources. They must be connected to the input sockets on the back of the device.

Displaying the inset picture

- 1 To display the inset picture, press »**PIP**« once.

Double window

- 1 To activate the double window function (split screen), keep pressing »**PIP**«.
 - The last selected main and inset pictures are shown next to each other.

Selecting the channels for the inset picture and the left side of the screen (double window)

- 1 Press »**P+**« or »**P-**« to move up and down channel positions one at a time.

Selecting the channels for the main picture and the right side of the screen (double window)

- 1 Press »**1...0**« to select channels directly, or select the video source (DVD player, video recorder, SAT receiver); then call the »Source table« menu by pressing »**AV**«, select the desired AV channel position with »**P+**« or »**P-**« and press »**OK**« to confirm.

Swapping the main and inset pictures

- 1 Press »**Z**« to swap the main and inset pictures.

Changing the position of the inset picture

- 1 Press »**P**« to move the inset picture.

Changing the size of the inset picture

- 1 Press »**S**« to change the size of the inset picture.

Ending the PIP function

- 1 To hide the inset picture, press »**PIP**« twice.

Quitting the double window

- 1 To quit the double window, press »**PIP**«.

TELETEXT MODE

TOP text or FLOF text mode

- 1 Press »TXT« to switch to teletext mode.
- 2 You can directly select teletext pages with »1...0«.

Note:

At the bottom of the screen, you will see an information line consisting of a red, green and, depending on the station, yellow and blue text field. Your remote control has buttons with the corresponding colours.

- 3 Press »👁« (red) to scroll back a page.
- 4 Press »🟢« (green) to scroll to the next page.
- 5 Press »🟡« (yellow) to select chapters.
- 6 Press »🟠« (blue) to select topics.
- 7 Press »TXT« to switch off teletext mode.

Normal text mode

- 1 Press »TXT« to switch to teletext mode.
- 2 You can directly select teletext pages with »1...0«.
- 3 Press »P-« to scroll back a page.
- 4 Press »P+« to scroll to the next page.
- 5 Press »TXT« to switch off teletext mode.

Additional functions

Skipping the waiting time

While a page is being searched for, you can switch to the television channel.

- 1 Enter the teletext page number using »1...0« and then press »P«. – As soon as the page is found, the page number is displayed.
- 2 Press »P« to switch to the teletext page.

Increasing character size

If you have difficulty reading the text on the screen, you can double the character size.

- 1 To enlarge the character size of a teletext page, press »?« repeatedly.



TELETEXT MODE



Page stop

A multiple page may contain several sub-pages, which are automatically scrolled by the transmitting station.

- 1 Stop the sub-pages with »**⏏**«.
- 2 Press »**⏏**« to quit the function.

Calling up a sub-page directly

If the selected teletext page contains further pages, the number of the current sub-page as well as the total number of pages is displayed.

- 1 Call up the sub-pages with »**S**«.
- 2 Press »**P-**« to scroll back a page.
- 3 Press »**P+**« to scroll to the next page.
- 4 Press »**S**« to quit the function.

Reveal answer

Certain teletext pages contain "hidden answers" or information which can be called up.

- 1 Display information with »**SCAN**«.
- 2 Conceal information with »**SCAN**«.

Split screen (Split Screen)

With this function you can see the television channel on the left and the teletext page on the right.

- 1 To activate the split screen function, press »**PAT**«.
– The television channel and the teletext page appear next to each other on the screen.
- 2 To deactivate the split screen function, press »**PAT**«.

CONVENIENCE FUNCTIONS

Convenience functions with the »Features« menu

- 1 To open the »MAIN MENU« press »i«.
- 2 Select »Features« with »P+« or »P-« and confirm with »OK«.

Note:

Further operation is explained in the following sections.

Changing the menu language

- 1 Select »Menu Language« with »P+« or »P-« and confirm with »OK«.
– The »Menu Language« menu appears.
- 2 Select the language with »P+«, »P-«, »◀« or »▶« and press »OK« to confirm.
- 3 Press »i« to finish the setting.

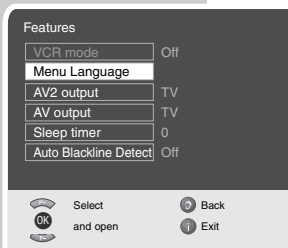

Entering the switch-off time for the sleep timer

You can enter a switch-off time. After this time has elapsed, the television switches to standby mode.

- 1 Select »Sleep timer« with »P+« or »P-« and press »OK« to confirm.
- 2 To enter the switch-off time (from 15 to 120 minutes), press »◀« or »▶«.
- 3 Press »i« to conclude the setting.

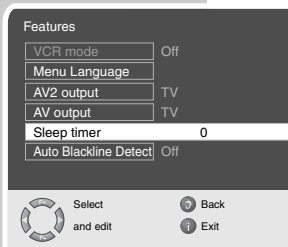

Automatic picture format modification (Auto Blackline Detect)

If this function is activated and a programme with black bars at the top and bottom is showing, the picture is enlarged proportionally.

- 1 Select »Auto Blackline Detect« with »P+« or »P-«.
- 2 Press »◀« or »▶« to activate or deactivate the function.
- 3 Press »i« to finish the setting.

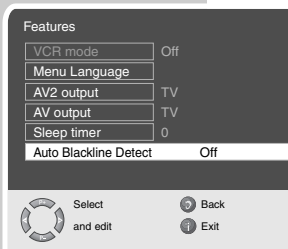

USING EXTERNAL DEVICES

DVD player, DVD recorder, video recorder or set-top box

Note:

Which television socket(s) you connect your external devices to depends on the sockets the external device is equipped with and the signals which are available.

Note that with many external devices the resolution of the video signal must be adapted to the input sockets on the television (check the external device's instruction manual). You can find out which values you need to set by referring to the guidelines in the section about connection options.

Note:

Do not connect any other equipment while the device is switched on. Switch off the other equipment as well before connecting it.

Only plug the device into the mains socket after you have connected the external devices.

High definition – HD ready

Your television can receive high-definition television signals (HDTV).

You can connect the input sources (HDTV set-top box or HDTV DVD player) to the »HDMI« socket or »DVI-D« (digital HDTV signal).

This ensures that you can view digital HDTV programmes, even if they are copy-protected (HDCP High-Definition Copy Protection).

Connecting a DVD player, DVD recorder, video recorder or set-top box

With a digital audio/video signal

Video signal: digital video; resolution: standard 576p; HDTV 720p, 1080i.

Audio signal: digital audio (stereo, multi-channel compression, uncompressed).

Channel position »HDMI«.

- 1 Connect the »HDMI« socket on the television and the corresponding HDMI socket on the external device using a standard HDMI cable (digital video and audio signal).

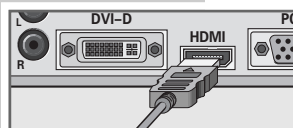

USING EXTERNAL DEVICES



With a digital audio/video signal

Video signal: digital video; resolution: standard 576p; HDTV 720p, 1080i.

Audio signal: stereo, analogue.

Channel position »DVI«.

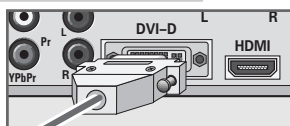

1 Connect the »DVI-D« socket on the television and the corresponding DVI socket on the external device using a standard DVI cable (digital video and audio signal).

2 Connect the »PC-DVI Audio In« socket (3.5 mm jack) on the television to the corresponding sockets on the external device with cinch cables (audio signal).



With an analogue video signal (progressive)

Video signal: YUV; resolution: standard 576p; HDTV 720p, 1080i.

Audio signal: stereo, analogue.

Channel position »YPBPR«.



1 Connect the »Y Pb Pr« sockets on the television and the corresponding sockets on the external device using cinch cables (video signal).

2 Connect the »Y Pb Pr Audio In L R« sockets on the television to the corresponding sockets on the external device using cinch cables (audio signal).

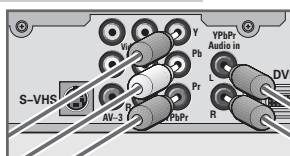

Using the Euro/AV socket

Video signal: FBAS/RGB (AV-1), FBAS (AV-2).

Audio signal: stereo, analogue.

Channel position »AV1« or »AV2«.

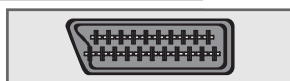

1 Connect the »AV-1« or »AV-2« socket on the television and the corresponding socket on the external device using a EURO-AV cable (video and audio signal).

Note:

You can copy recordings via the television from one external device to another by connecting the playback device to the »AV-1« socket and the recording device to the »AV-2« socket, then selecting the »AV1« channel. However, you will not be able to watch a television channel.

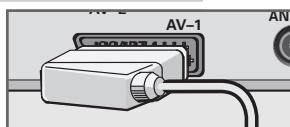

Using the EURO/AV socket (S-Video signal)

Video signal: FBAS Y/C.

Audio signal: stereo, analogue.

Preset »AV2S«.

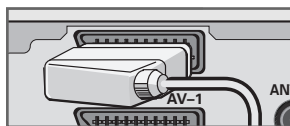

1 Connect the »AV-2« socket on the television and the corresponding socket on the external device using a EURO-AV cable (video and audio signal).

USING EXTERNAL DEVICES

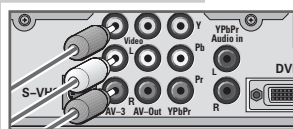
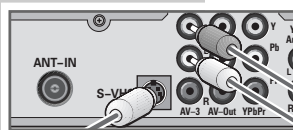

With S-Video signal

Video signal: Y/C.

Audio signal: stereo, analogue.

Channel position »SVHS«.

- 1 Connect the »S-VHS« socket on the television and the corresponding socket on the external device using an S-Video cable (video signal).
- 2 Connect the »AV-3 L R« sockets on the television to the corresponding sockets on the external device using cinch cables (audio signal).

With an analog TV signal

Video signal: FBAS.

Audio signal: stereo, analogue.

Channel position »AV3«.

- 1 Connect the »AV-3 Video« cinch socket on the television and the corresponding socket on the external device using cinch cables (video signal).
- 2 Connect the »AV-3 L R« sockets on the television to the corresponding sockets on the external device using cinch cables (audio signal).

Using a video recorder, DVD player or set-top box

- 1 Switch on the video recorder, DVD player or set-top box and select the function you wish to use.
- 2 Press »AV«, select the input signal channel with »P+« or »P-« (»AV1«, »AV2«, »AV3«, »SVHS«, »HDMI«, »DVI« or »YPBPR«) and press »OK« to confirm.

Switching VCR mode on and off

On certain video recorders, you can improve the picture stability of the playback using this mode.

- 1 Press »AV«, select the channel with the connected VCR with »P+« or »P-« and press »OK« to confirm.
- 2 Call up the »MAIN MENU« menu with »i«. – The »MAIN MENU« menu appears.
- 3 Select »Features« with »P+« or »P-« and press »OK« to confirm.
- 4 Select »VCR mode« with »P+« or »P-« and select »On« with »<« or »>«.
- 5 Press »i« to conclude the setting.

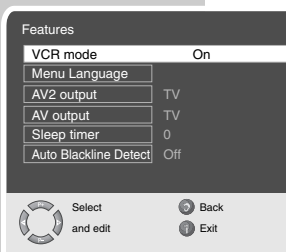

USING EXTERNAL DEVICES

Selecting the signal for the AV output

With this setting you can select which signal is output at the Euro-AV socket AV1 or at the AV OUT V L R cinch sockets.

The television station or the video/audio signal from connected devices.

This enables you to transmit recordings from one external device (e.g. a DVD player) to another using the television. Connect the playback device to Euro-AV socket AV1 and the recording device to Euro-AV socket AV2 and select the setting you require in the »Special functions« menu.

– AV 2 output:

»TV« – the television channel that you are viewing or

»AV3« – the audio/video signal from the cinch sockets (AV3).

– AV output:

»TV« – the television channel that you are viewing or

»AV2« – the audio/video signal from the Euro-AV socket AV2.

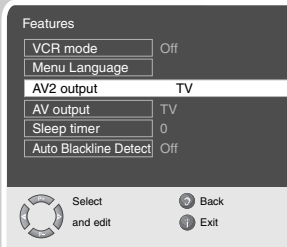

- 1 Call up the »MAIN MENU« menu with »i«.
- 2 Select »Features« with »P+« or »P-« and press »OK« to confirm.
- 3 Select »AV2 output« or »AV output« with »P+« or »P-«.
- 4 Select the desired option with »◀« or »▶«.
- 5 Press »i« to conclude the setting.

USING EXTERNAL DEVICES

Decoder or satellite receiver

In order for the television to receive encoded programs from a privately operated station, a decoder is needed.

Connecting a decoder or satellite receiver

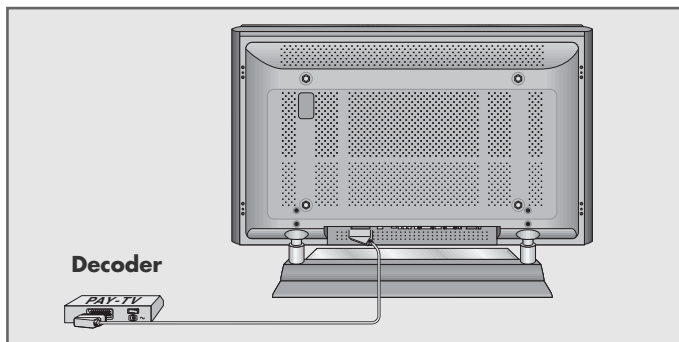

- 1 Connect the »AV-1« socket on the television set and the appropriate socket on the decoder using a EURO-AV cable.

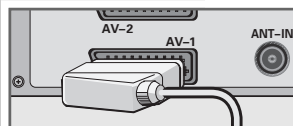

Using a decoder or satellite receiver

- 1 Switch on the television and the decoder or the satellite receiver.
- 2 Press »AV«, select the channel »AV1« with »P+« or »P-« and press »OK« to confirm.

Hi-fi system/AV receiver

Connecting the hi-fi system/AV receiver

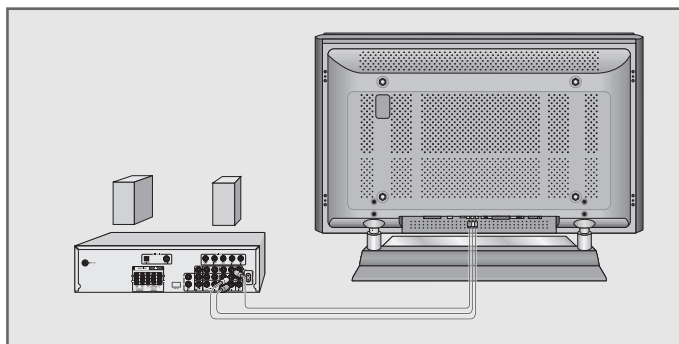

- 1 Connect the white and red sockets »AV-Out L R« on the television and the corresponding sockets on the hi-fi system/AV receiver with a cinch cable.
- 2 Connect the yellow »AV-Out Video« socket on the television to the corresponding socket on the AV receiver using a cinch cable (video signal).

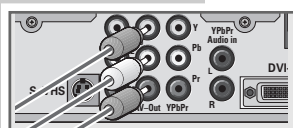

USING EXTERNAL DEVICES

Camcorder

Connecting the camcorder

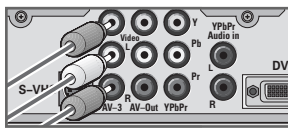
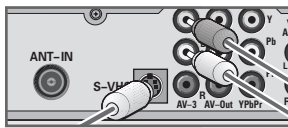
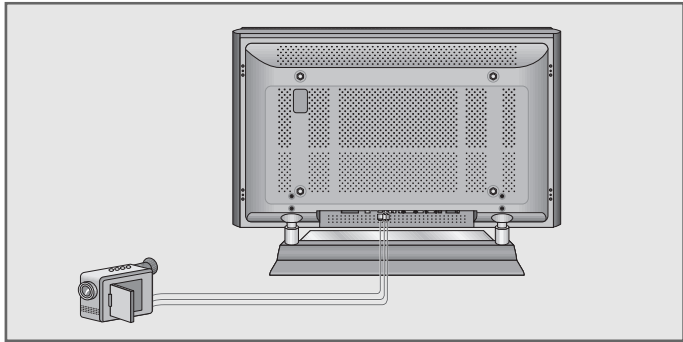

- 1 Connect the yellow socket »**AV-3 Video**« on the television and the corresponding socket on the camcorder (VHS, Video 8) with a cinch cable (picture signal);

or

connect the »**S-VHS**« socket (picture signal) on the television and the corresponding socket on the camcorder (S-VHS, Hi 8) with a S-Video cable.

- 2 Connect the white and red sockets »**AV-3 L R**« on the television and the corresponding sockets on the camcorder with a cinch cable (audio signal).

Note:

There must not be video signals at »**AV-3 Video**« and »**S-VHS**« sockets at the same time. This could lead to picture disturbances.

Operating with a camcorder

- 1 Switch on the camcorder, insert a cassette and start playback.
- 2 Press »**AV**«, select the »AV3« or SVHS« channel with »**P+**« or »**P-**« and press »**OK**« to confirm.

PC MONITOR MODE

Connecting a PC

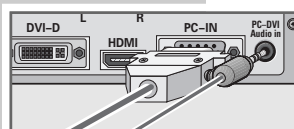
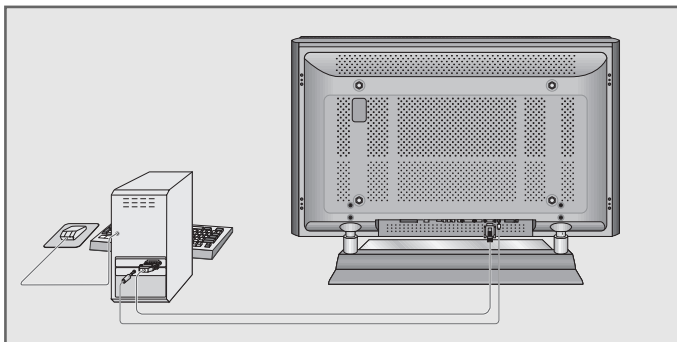

- 1 Connect the socket »PC-IN« or »DVI-D« on the television to the corresponding socket on the PC using a VGA cable.
- 2 Connect the socket »PC-DVI Audio In« on the television to the corresponding socket on the PC using a cinch cable (audio signal).

Note:

Adjust your PC to the monitor (for example, picture resolution 1366 x 768, picture frequency 60 Hz).

Selecting the channel position for the PC

- 1 Press »AV«, select the »PC« or »DVI« channel with »P+« or »P-« and press »OK« to confirm.

Settings for the PC

- 1 Press »i« to open the »MAIN MENU« menu.
– The »MAIN MENU« menu appears.
- 2 Select »Picture« with »P+« or »P-« and press »OK« to confirm.
– The »Picture« menu appears.
- 3 Select »Brightness« with »P+« or »P-« and press »P+« again.
– The second page of the picture menu appears.
- 4 Press »P+« or »P-« to select the function or setting.
– Options:
»H Position« – adjust the horizontal picture position
»V Position« – adjust the vertical picture position
»Phase« – removes horizontal flicker, blurring and horizontal lines
»Auto position« – for automatic adjustment to the PC
- 5 Press »OK« to activate the function and »◀« or »▶« to adjust.
- 6 Press »i« to finish the setting.

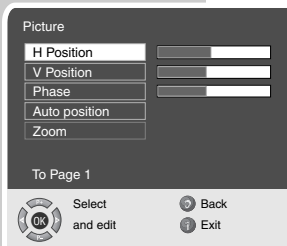

SPECIAL SETTINGS

Setting television channels

This setting is only necessary if a new channel comes on air and you do not want to change the order of your channels. The television channel can be set directly or using the search.

Setting channels using the search

- 1 Press »i« to open the »MAIN MENU«.
– The »MAIN MENU« appears.
- 2 Select »Setup« with »P+« or »P-« and confirm with »OK«.
– The »Setup« menu appears.
- 3 Select »Installation« with »P+« or »P-« and confirm with »OK«.
- 4 Select »Program no« with »P+« or »P-« and set the preset channel with »◀« or »▶«.
- 5 Select »Search« with »P+« or »P-« and start the search with »◀« or »▶«.
– If a strong station signal is received, the search is interrupted and the picture appears. Repeat the search until the channel you want appears on the screen.

Note:

The current system is automatically displayed in the »System« line. Select »System« with »P+« or »P-« if the colour or sound are incorrect. Select the setting required with »◀« or »▶«.

- 6 Select »Store« with »P+« or »P-« and confirm with »OK«.
– The »Stored« message appears.

Note:

To set other television stations, repeat steps 3 to 6.

- 7 Press »i« to finish the setting.

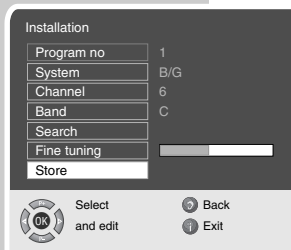
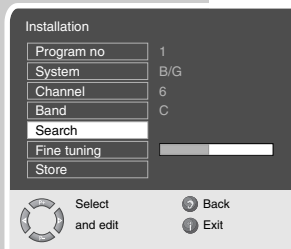
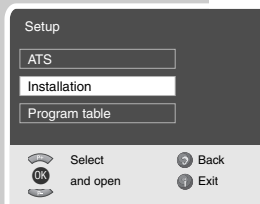

SPECIAL SETTINGS

Fine tuning television channels

The television automatically tunes itself to the best possible reception. You may need to carry out manual fine tuning in areas where there is poor reception.

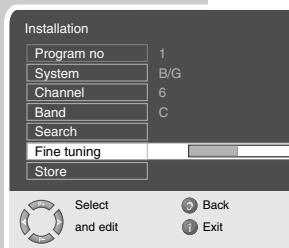

- 1 Press »i« to open the »MAIN MENU«. – The »MAIN MENU« appears.
- 2 Select »Setup« with »P+« or »P-« and confirm with »OK«. – The »Setup« menu appears.
- 3 Select »Installation« with »P+« or »P-« and confirm with »OK«.
- 4 Select »Fine tuning« with »P+« or »P-« and set it with »◀« or »▶«.
- 5 Select »Store« with »P+« or »P-« and confirm with »OK«. – The »Stored« message appears.
- 6 Press »i« to finish the setting.

Setting the television channels by entering the channel numbers

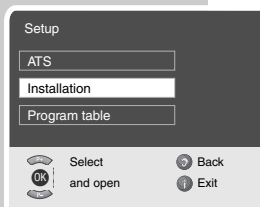

- 1 Press »i« to open the »MAIN MENU«. – The »MAIN MENU« appears.
- 2 Select »Setup« with »P+« or »P-« and confirm with »OK«. – The »Setup« menu appears.
- 3 Select »Installation« with »P+« or »P-« and confirm with »OK«.
- 4 Select »Program no« with »P+« or »P-« and set the preset channel with »◀« or »▶«.
- 5 Select »Band« with »P+« or »P-«.
- 6 Press »◀« or »▶« to choose between »S« (special channel) and »C« (channel).
- 7 Select »Channel« with »P+« or »P-«.
- 8 Press »◀« or »▶« to switch up and down channels or use »1...0« to enter the channel number directly.

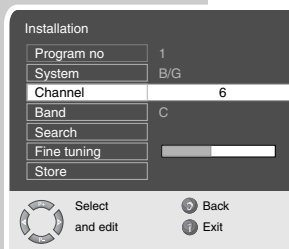

Note:

The current system is automatically displayed in the »System« line. Select »System« with »P+« or »P-« if the colour or sound are incorrect. Select the setting required with »◀« or »▶«.

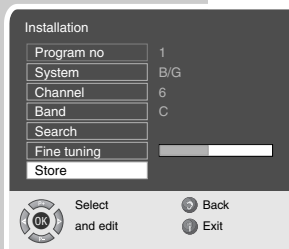

- 9 Select »Store« with »P+« or »P-« and confirm with »OK«. – The »Stored« message appears.

Note:

To set the other television stations, repeat steps 3 to 9.

- 10 Press »i« to finish the setting.

SPECIAL SETTINGS

Re-tuning all television channels

You can re-tune all the television stations, for example if you move to another town.

- 1 Press »i« to open the »MAIN MENU«.
- 2 Select »Setup« with »P+« or »P-« and confirm with »OK«.
– The »Setup« menu appears.
- 3 Select »ATS« with »P+« or »P-« and confirm with »OK«.
– The »ATS« menu appears.
- 4 Press »◀« or »▶« to select the country.
- 5 Select »Autoprogram« with »P+« or »P-« and confirm with »OK«.
– A warning message appears.
- 6 Press »⌚« (green) to start the search.
– The search begins. It may last a few minutes, depending on the number of television stations found.
– The automatic search may last a few minutes, depending on the number of television channels received.

Note:

You can interrupt the search by pressing »OK«.

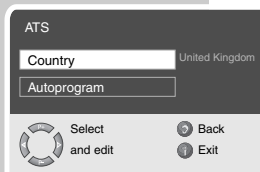
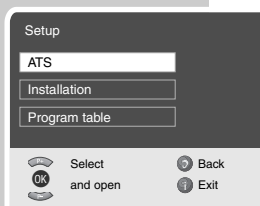

INFORMATION

Technical data

Operating voltage:	100 - 240 V, 50/60 Hz
Power consumption:	in operation 175 W in standby approx. 2 W (Elegance 37) in operation 240 W in standby approx. 2 W (Elegance 40)
Sound output:	2 x 20 watts music (2 x 10 sine wave)
Reception range:	C01 ... C80, special channels S01 ... S41
Preset channels:	99 and 8 AV
Screen size:	94 cm/37" (Elegance 37) 102 cm/40" (Elegance 40)
Max. resolution:	WXGA 1366 x 768
Weight (WEEE):	approx. 32,20 kg (Elegance 37) approx. 35,20 kg (Elegance 40)

Service information for dealers

The television set may only be operated with the mains adapter supplied.

The product complies with the following EU directives: 73/23/EEC directive for electrical equipment to be used within defined voltage ranges. 89/336/EEC directive on electromagnetic compatibility.

The device complies with the following standards: EN 60065, EN 55013, EN 55020.

Environmental note

This product has been made from high-quality parts and materials which can be re-used and recycled.

Therefore, do not throw the product away with normal household waste at the end of its life. Take it to a collection point for recycling electrical and electronic devices. This is indicated by this symbol on the product, in the operating manual and on the packaging.

Please find out about collection points operated by your local authority.

Help protect the environment by recycling used products.



INFORMATION

Troubleshooting

If the remedies given below do not work, please consult an authorised GRUNDIG dealer. Please bear in mind that malfunctions can also be caused by external devices such as video recorders or satellite receivers.

Fault	Possible cause	Remedy
Screen lit (snow), but no station	Antenna cable	Is the antenna cable connected?
	No television station programmed	Start the station search
Poor picture contrast	Picture settings incorrectly set	Adjust the brightness, contrast or colour setting
	Problem at station	Test with another channel
Interference to picture and/or sound	Interference from other devices	Change the position of the device
Ghosts, reflection	Channel setting	Automatic or manual channel setting/fine tuning
	Antenna	Have antenna cable or system checked
No colour	Colour intensity at minimum	Turn up the colour
	TV standard setting (if setting option is available)	Select the correct colour standard
	Problem at station	Test with another channel
Picture but no sound	Volume set to minimum	Turn up or switch on the volume
	Problem at station	Test with another channel
Teletext missing or faulty	Television station (has no teletext) or antenna system	Test another channel for fine tuning and ghosts
	Station signal too weak	Check the antenna system
Remote control does not work	No optical connection	Point the remote control at the television set
	Remote control batteries	Check the batteries, change if necessary
	Operating condition undefined	Switch off the television with the main power button for approximately 2 minutes
Picture is dark in PC mode	Incorrect setting for picture resolution and picture frequency on the PC	Change the setting on the PC (for example, picture resolution 1366 x 768, picture frequency 60Hz)

INFORMATION

Additional Information for units sold in the UK.

Units sold in the UK are suitable for operation from a 240V ac, 50Hz mains supply.

The range of multi-system receivers is built to work in most European countries. However, the mains plug and socket system for the UK differs from many European countries.

This appliance has been supplied with a fitted, non-removable, approved converter plug for use in the UK. This converter plug is fitted with a 5A rated fuse.

In case this appliance is supplied with a moulded 2-pin Euro plug only, which is unsuitable for UK operation, this must be cut off and immediately disposed of. An approved 13A, 3-pin UK plug should then be fitted by a qualified electrician.

Note:

The severed Euro plug must be destroyed to avoid a possible shock hazard should it be inserted into a socket elsewhere.

If a non-rewireable 3-pin plug or a rewireable 13A (BS1363) 3-pin plug is used, it must be fitted with a 5A ASTA or BSI approved BS1362 fuse. If any other type of plug is used it must be protected by a 5A fuse either in the plug, or at the distribution board. If this type of plug becomes defective, ensure that the fuse is removed before disposal, to eliminate potential shock hazard.

If it is necessary to change the fuse in the non-rewireable plug, the correct type and rating (5A ASTA or BSI approved BS1362) must be used and the fuse cover must be refitted. If the fuse cover is lost or damaged, the lead and plug must not be used until a replacement is obtained. Replacement fuse covers should be obtained from your dealer.

Important:

The wires in the mains lead are colour coded in accordance with the following code:

BLUE – NEUTRAL

BROWN – LIVE

As the colours of the wires in the mains lead of your appliance may not correspond with the coloured marking identifying terminals in your plug, proceed as follows:

Connect the BLUE coloured wire to plug terminal marked with the letter "N" or coloured black.

Connect the BROWN coloured wire to the plug terminal marked with the letter "L" or coloured red.

In no circumstance must any of the wires be connected to the terminal marked with the letter "E", earth symbol "⏏", coloured green, or green & yellow.

